

# 468 SIDE LINK 3" SLANT WALL, RIGHT HAND

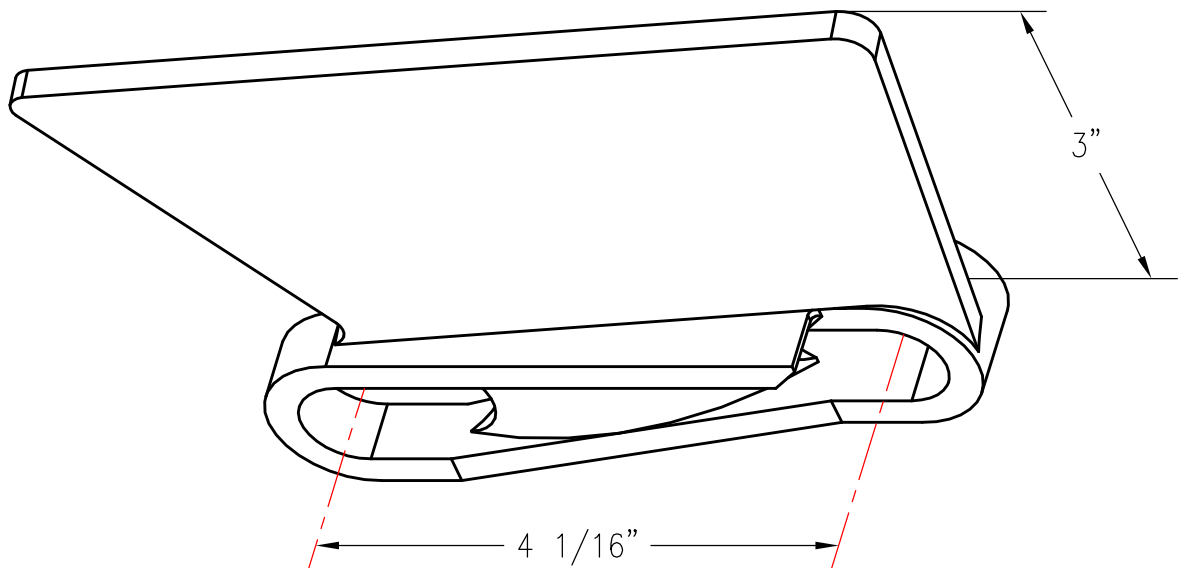

PATTERN NUMBER: CC-6066  
DRAWING NUMBER: CA-2089-D

M041

WEIGHT: 2.25#